

Hardware:

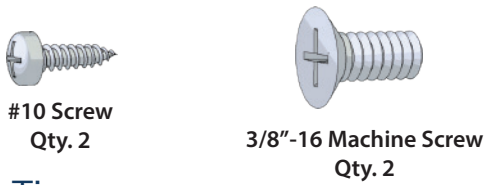

Installation Tips:

- When installing base plate, place the upright pole on a countertop or elevated surface, then attach base.

Suggested Tools:



Assembly:

- 1 After removing contents from box, attach baseplate to upright using 3/8"-16 machine screws.

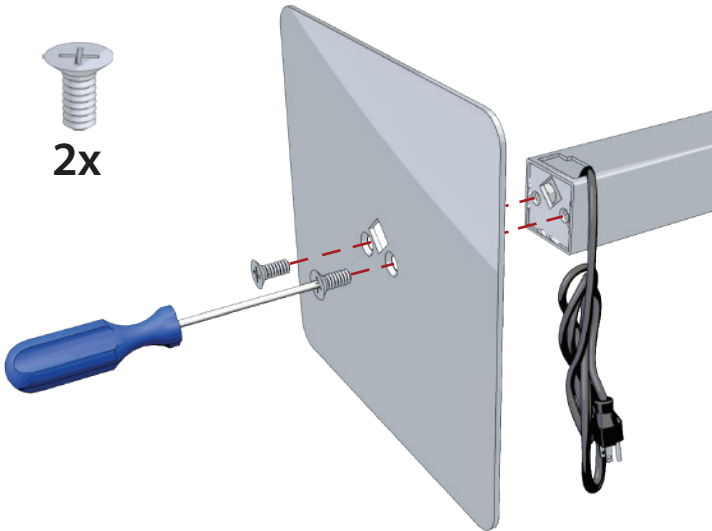

NOTE: Make sure the square cutouts line up..

- 2 Slide the charging unit down into the aluminum mounting bracket.

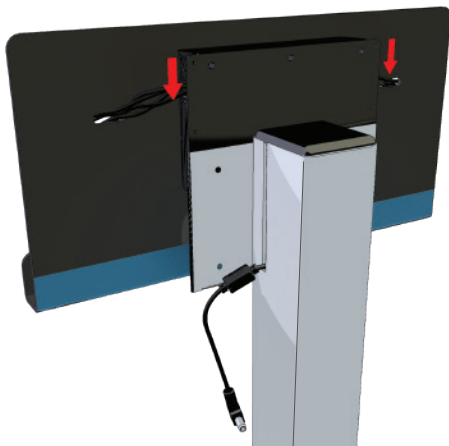

Assembly Continued:

- 3 Secure the charging unit to the mounting bracket with #10 screws.

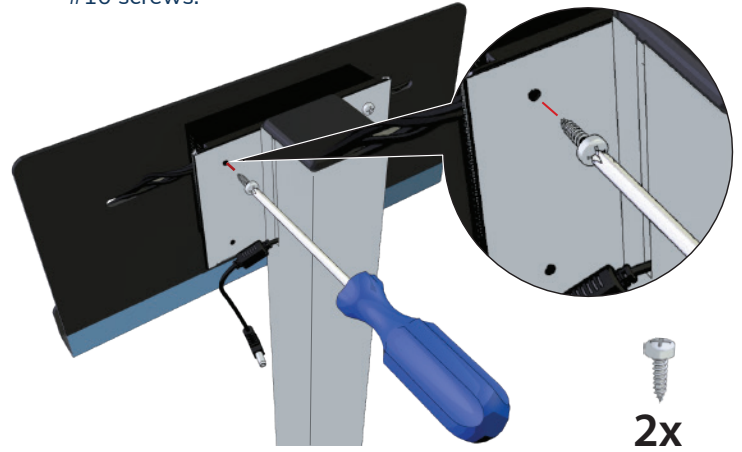

- 4 Plug the power jack into the bottom of the technology box.

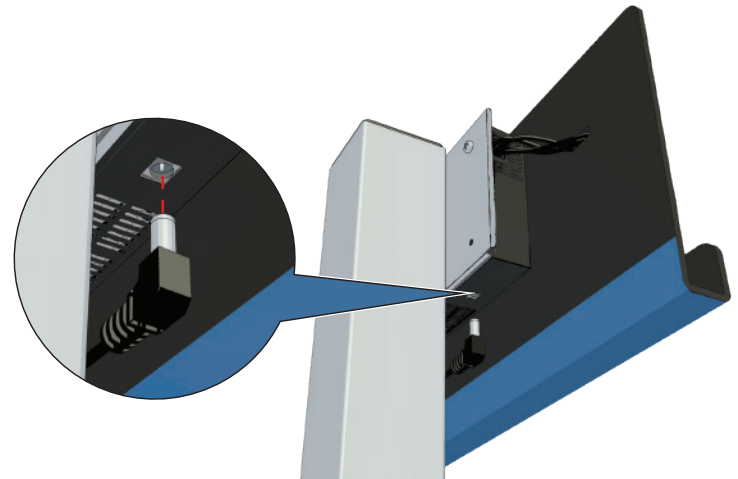

- 5 Now that the charger is assembled, it can be plugged in. The power cable will plug into any standard wall outlet or power strip.

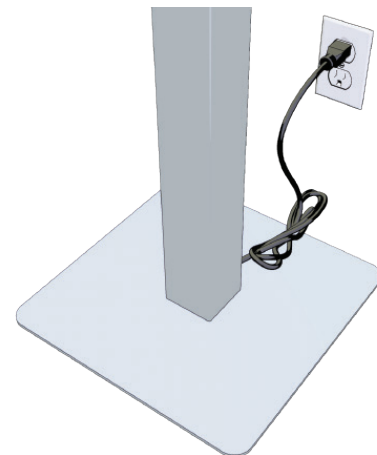

IMPORTANT: Phone/tablet charging only.
Not compatible with laptops.

Need more info?

Hardware:



Replacement charging cables

Installation Tips:

- Instructions may vary from wall mount to floorstand versions

Suggested Tools:



Phillips Screwdriver

Assembly:

- 1 Unplug power supply source to floorstand or wallmount station.

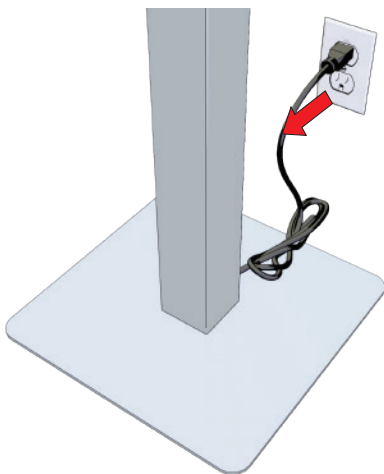

- 2 Unplug power jack from charging station. Unscrew the security screws from the back of the floor stand.

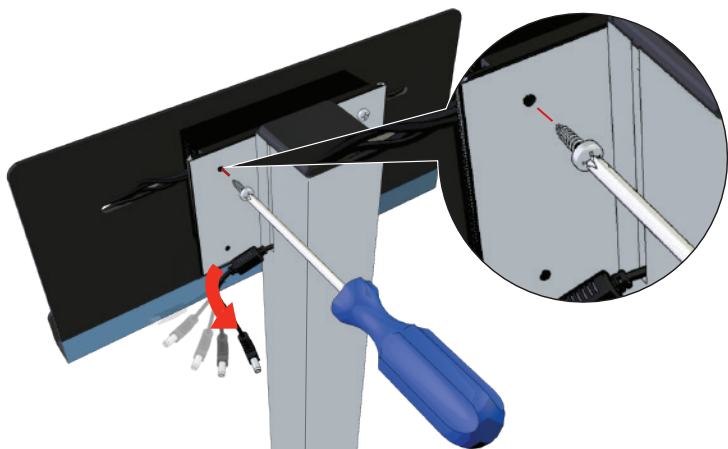

TIP: Set the screws down in a safe spot to ensure they're not lost.

- 3 Slide the charging unit up from the metal mounting bracket that is attached to the floor stand accessory.

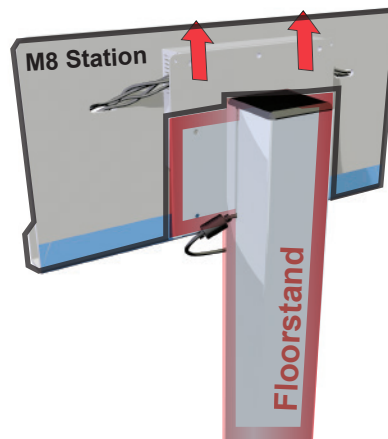

- 4 Once removed place onto a flat surface remove the Phillips head screws from the tech box. Set the screws down in a safe place to prevent loss.

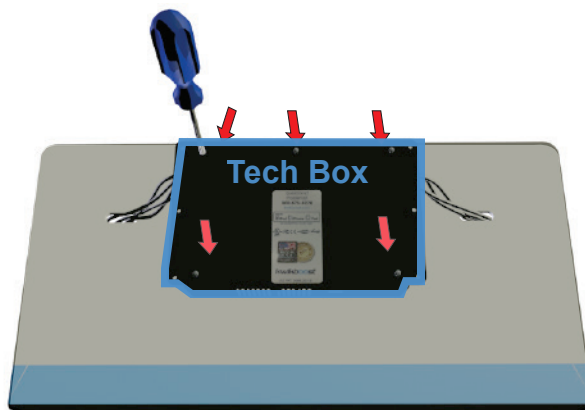

- 5 Remove old charging cables by unplugging them from the USB ports on the circuit board, then sliding them through the small slots in the billboard. Next, plug in your new charging cables. Finally, reassemble the charging station in reverse order of disassembly.

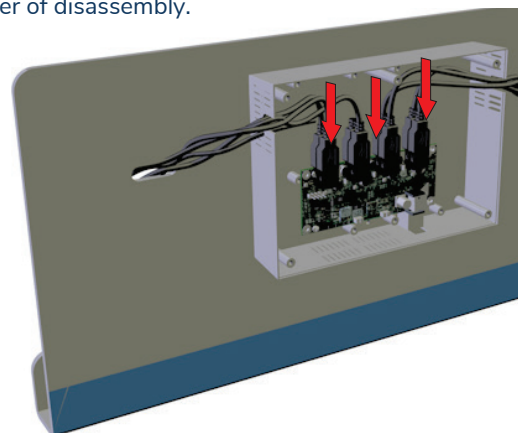

IMPORTANT: Phone/tablet charging only. Not compatible with laptops.

Need more info?